

# terraçade

CERAMIC FAÇADE SYSTEM



Glen-Gery



# Prefinished colorfast system.

Creativity meets practicality. Appealing to both the creative and the practical, Terraçade has been designed to complement a diverse range of architectural styles, while the Terraçade system radically simplifies and speeds up the entire design and installation process. The complete Terraçade collection is prefinished and colorfast, meaning it will look as vibrant today as it will in 100 years.



PRODUCT: TN Watermark  
COLOR: Impara  
PROJECT: Brickworks Estate  
BUILDER: Goodman



# Enduring ceramic façade.

---

Performance driven, Terraçade products are built for outstanding durability and performance. With an unmatched 100 year warranty the authentic natural clay material ensures the tiles easily withstand every extreme of weather, from intense UV, heat and even fire, to heavy storms and freezing temperatures. Providing a completely maintenance-free finish that is low carbon and energy efficient.





PRODUCT: XP Glazed  
COLOR: Brilliant White  
PROJECT: Notre Dame College Science Centre  
ARCHITECT: Baldasso Cortese



**Timeless innovation  
plus unrivaled colors  
and finishes.**

---

**The evolution  
Terraçade TN**

Beautifully thin and sleek, the Terraçade TN range is the pinnacle of ceramic façades. Available in an impressive range of colors and finishes, Terraçade TN is perfectly suited for the modern era.



## TN Smooth

TN Smooth is the harmony of nature and design, its pleasing earthy colors contrasting its matte finishes.

## TN Glazed

The bold colors and lustrous finish of TN Glazed will liven up any environment.

## TN Watermark

TN Watermark provides the low maintenance benefits of ceramics, with a beautiful timber grain finish.

## TN Sand Blast

Texturally rich, the sand blasted finish subtly plays with light and shade creating a softer, organic finish.

# Terraçade TN Colors and Finishes

Terraçade | TN Tiles

SAND BLASTED



White



Cream



Charcoal

SMOOTH



Sandy



Raglan

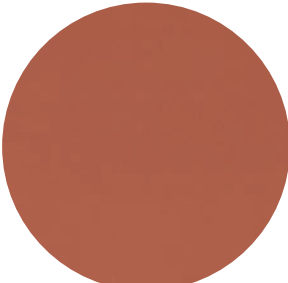

Gibson

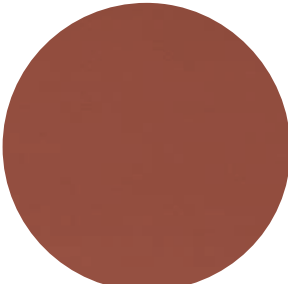

Tanami



Sturt

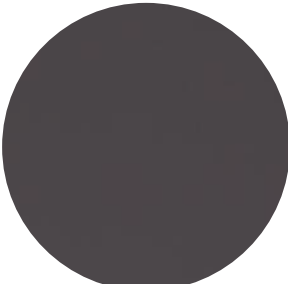

Simpson

WATERMARK



Larapinta



Impara



GLAZED



Brilliant White

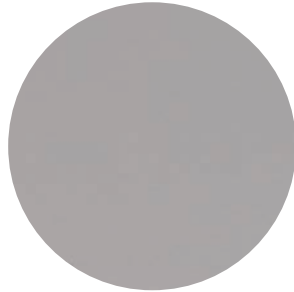

Brilliant Grey

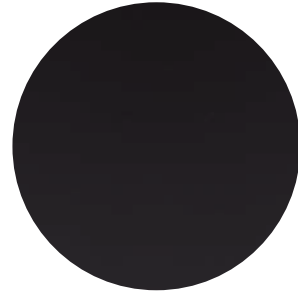

Brilliant Black

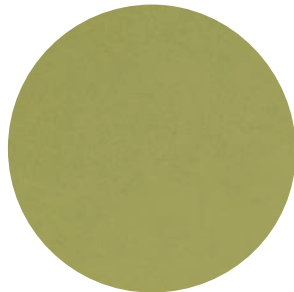

Brilliant Green

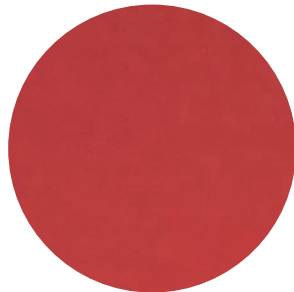

Brilliant Red

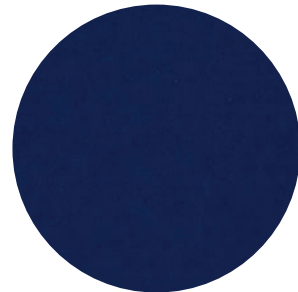

Brilliant Blue

## Product information

### Sizes:

11<sup>13</sup>/<sub>16</sub>" x 46<sup>3</sup>/<sub>4</sub>" (300mm x 1188mm)



11<sup>13</sup>/<sub>16</sub>" x 23<sup>1</sup>/<sub>8</sub>" (300mm x 588mm)



### Warranties



Color for Life  
Warranty



100 Year Product  
Warranty



20 Year System  
Warranty



Terraçada | Baguettes

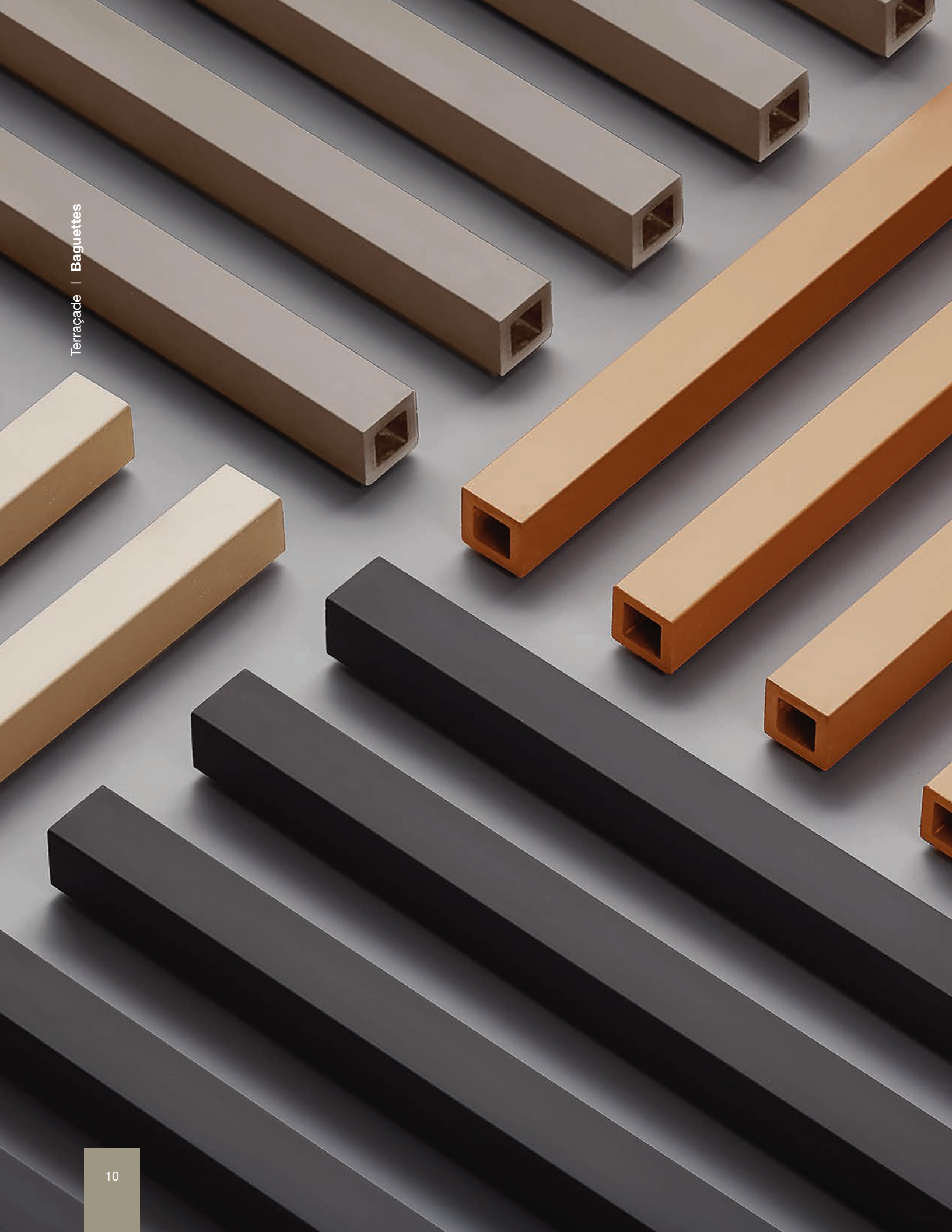



# Baguettes

Terraçade baguettes have been designed with flexibility in mind. Whether it's performing a privacy function or providing ventilation and shading against the elements, the baguettes will make a statement for any residential, commercial or industrial building.



Sandy



Raglan

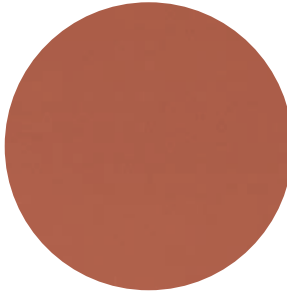

Gibson

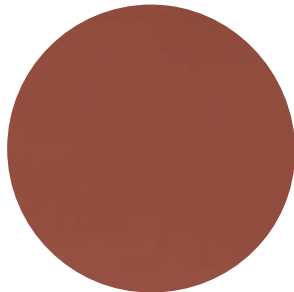

Tanami



Sturt

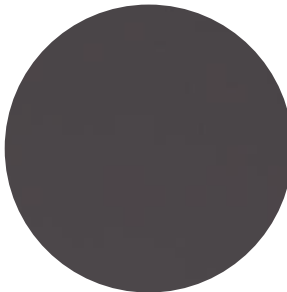

Simpson

## Product information

### Sizes:

39<sup>3</sup>/<sub>8</sub>" L x 2" W x 2" H (1000 L x 50 W x 50 H mm)



### Warranties



Color for Life  
Warranty



100 Year Product  
Warranty



20 Year System  
Warranty





PRODUCT: TN Smooth  
COLOR: Gibson  
PROJECT: Shenyang Youth Activity Centre



PRODUCT: TN Glazed  
COLOR: Brilliant White  
PROJECT: Apex Apartments  
ARCHITECT: Apex Builder  
PHOTOGRAPHER: Black Bee Photography

PRODUCT: TN Watermark  
COLOR: Impara  
PROJECT: Brickworks Estate  
BUILDER: Goodman



# Terraçade TN Accessories

Terraçade | Accessories



## TN SET OUT TOOL

Used to assist in setting out the Terraçade TN Suspension Rails that hold the TN tiles in place.



## TN FITMENT SPONGE

When a Terraçade tile is clipped onto the suspension rails (top and bottom) there is a gap between the secured points at the top and the bottom rail where the tile is not fully supported laterally.

The fitment sponge is installed halfway down the tile on the back, centered between the suspension rails vertically and acts to prevent lateral movement of the tile. Four sponges are used for each Terraçade tile.

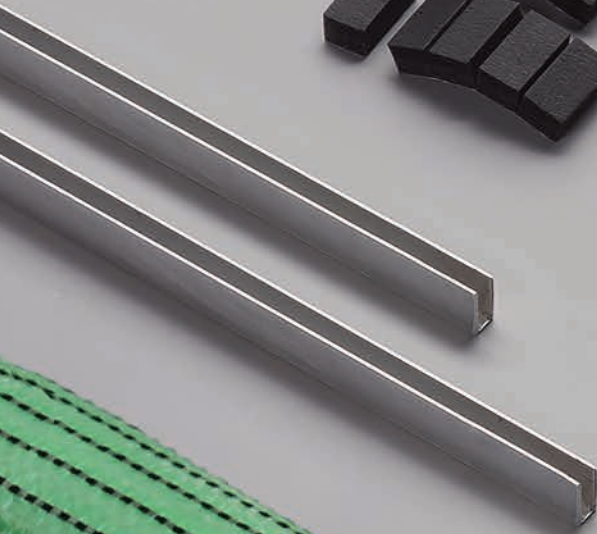

## TN JOINT ANGLE AND CHANNEL

Is used between Terraçade TN tiles to create a clean joint between tiles. This extrusion also helps secure the Terraçade tiles in place.



## DRAINING AIR AND WATER BARRIER MEMBRANE

Usually the first component of the system fixed the wall frame, this membrane resists the ingress of water and meets requirements for air barrier materials, while its vapor-permeability and enhanced contours facilitate drying and drainage.

### **TN SURROUND**

This aluminium extrusion is used at the edges (top and sides) of the Terraçade cladded area—it sits around the outside to be create a neat finish and to hold/connect the Terraçade tile to the building frame.

### **TN EXTERNAL CORNER**

This aluminium extrusion finishes the edges of TN tiles at external corners.

### **TN INTERNAL CORNER**

This aluminium extrusion finishes the edges of TN tiles at internal corners.

### **TN SUSPENSION RAIL**

This galvanized steel rail is fixed to the wall frame in a vertical format and provides the anchor points for the Terraçade tiles to clip on to.



# Terraçade TN Installation

## Terraçade TN 600 Installation

23<sup>5</sup>/<sub>8</sub>" (600mm) Module consists of tile and jointing strip

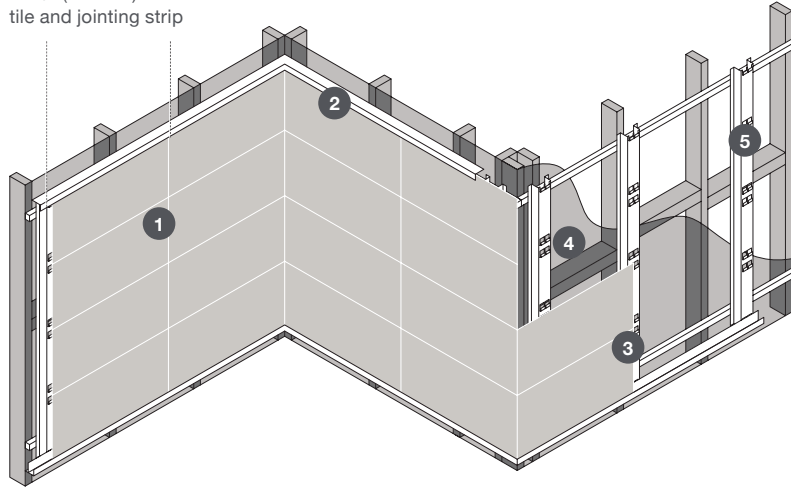

KEY:

- 1 Jointing strip
- 2 Trims
- 3 Tiles
- 4 Membrane
- 5 Vertical rails

Application	Length	Module Height	Thickness	Lbs./sq. ft.
Internal + External Cladding	23 <sup>5</sup> / <sub>8</sub> " and 46 <sup>3</sup> / <sub>4</sub> "	11 <sup>13</sup> / <sub>16</sub> "	9 <sup>1</sup> / <sub>16</sub> "	5.12

## Terraçade TN 1200 Installation

47<sup>1</sup>/<sub>4</sub>" (1200mm) Module consists of tile and jointing strip

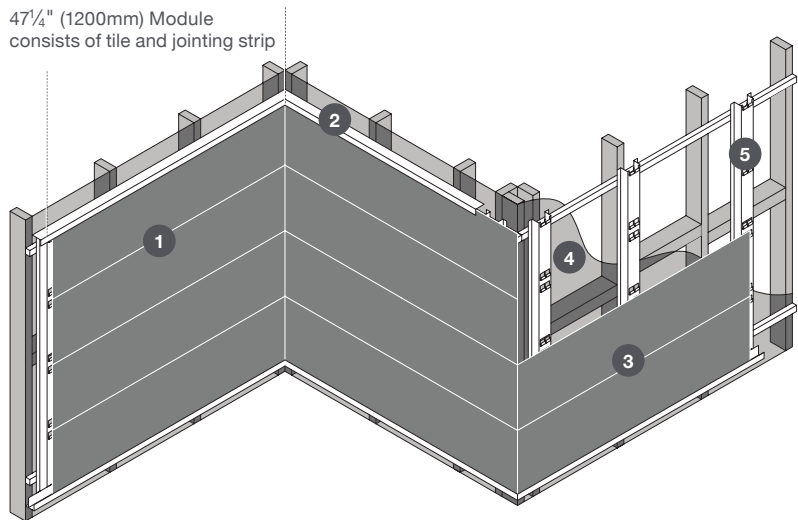

KEY:

- 1 Jointing strip
- 2 Trims
- 3 Tiles
- 4 Membrane
- 5 Vertical rails

## Terraçade TN Installation Recommendations

### SEALERS

While Terraçade TN offers a low maintenance solution to building façades, there may be instances where more severe conditions exist, such as high traffic areas prone to graffiti. For added protection a sealer may be used.

# Terraçade TN Technical Information

	Terraçade TN 600	Terraçade TN 1200
<b>Length</b>	23 <sup>1</sup> / <sub>8</sub> " (588mm)	46 <sup>3</sup> / <sub>4</sub> " (1188mm)
<b>Module Height</b>	11 <sup>13</sup> / <sub>16</sub> " (300mm)	11 <sup>13</sup> / <sub>16</sub> " (300mm)
<b>Thickness</b>	<sup>9</sup> / <sub>16</sub> " (14mm)	<sup>9</sup> / <sub>16</sub> " (14mm)
<b>Tiles/Sq. ft.</b>	.52 (5.6/2.7 m <sup>2</sup> )	.52 (5.6/2.7 m <sup>2</sup> )
<b>Lbs./Tile</b>	9 (4.5kg)	18 (9kg)
<b>Lbs./Sq. ft.</b>	5.12 lbs./269.1 sq. ft. (25/25kg)	5.12 lbs./269.1 sq. ft. (25/25kg)
<b>Break Strength (longitudinal)</b>	464.45 lbs. (1.7kN)	464.45 lbs. (1.7kN)
<b>Break Strength (transverse)</b>	1,284.06 lbs. (4.7kN)	1,284.06 lbs. (4.7kN)
<b>Coefficient of Expansion</b>	<0.02%	<0.02%
<b>Coefficient of Thermal Expansion</b>	5.6 x 10 <sup>-7</sup> per °F	5.6 x 10 <sup>-7</sup> per °F
<b>Durability Class</b>	Exposure Grade	Exposure Grade
<b>Flammability Index</b>	0	0
<b>Ignitability Index</b>	0	0
<b>Spread of Flame Index</b>	0	0
<b>Heat Evolved Index</b>	0	0
<b>Smoke Developed Index</b>	1	1
<b>Combustibility</b>	PASS – Not deemed combustible	PASS – Not deemed combustible



# Designed to last.

**Versatile in design, easy to install and with low maintenance upkeep, Terraçade completes all the steps for any residential, commercial or industrial project.**

## **HIGH DURABILITY**

Performs in any environment from extreme heat to freezing temperatures.

## **ENERGY EFFICIENT**

A sustainable material made from natural and recycled material, it naturally assists with airflow and energy reduction.

## **FIRE RESISTANT**

Made from non-combustible material.

## **TERMITE RESISTANT**

No wood, no termites, no degradation.

## **LOW MAINTENANCE**

Life-long colorfastness with a maintenance-free finish.

## **SUPERIOR STRENGTH**

Manufactured for maximum strength and impact resistance.



High durability



Energy efficient



Fire resistant



Termite resistant



Low maintenance



Superior strength



PRODUCT: TN Glazed  
 COLOR: Brilliant White  
 PROJECT: Notre Dame College Science Centre  
 ARCHITECT: Baldasso Cortese

**Not all façade materials are the real deal.  
 Terraçade stands behind all of its products  
 that are rigorously tried and tested to meet  
 strict standards.**

**COLORFAST**

Terraçade tiles will not fade or change color when used in normal weather conditions.

**QUALITY TILES**

Terraçade tiles used in the Terraçade Façade system are free from defects in materials for a period of 100 years from the date of delivery.

**ENDURING SYSTEM**

Terraçade Façade system hanging rails are free from defects in materials and workmanship for a period of 20 years from the date of delivery.



Color for Life  
 Warranty



100 Year Product  
 Warranty



20 Year System  
 Warranty





Discover the possibilities at [glengery.com](http://glengery.com)

Front cover:

PRODUCT: TN Smooth  
COLORS: Off-white and Dark Grey

A BRAND OF

**BRICKWORKS**

Due to printing limitations, color and texture may vary from actual product. Final selection should always be based on an actual product sample. For more information, contact your Glen-Gery representative. © 2020 Glen-Gery Corporation • 11/20/TSG/10M